



KATALOG 2020 | 2020 CATALOGUE

MASTERLINE
by Bisk

MASTERLINE

by Bisk

MASTERLINE by BISK to marka dedykowana klientom instytucjonalnym, wchodząca w skład portfolio Grupy BISK S.A., polskiego producenta akcesoriów łazienkowych, działającego na wszystkich najważniejszych rynkach europejskich. Zgromadzone przez lata doświadczenie Grupy zaowocowało stworzeniem gamy produktów, które poprzez rygorystyczną kontrolę jakości oraz uniwersalne wzornictwo doskonale wpisują się w charakter przestrzeni publicznej.

MASTERLINE by BISK is a brand dedicated to the institutional clients and is part of the BISK SA Group, a long-established Polish producer of bathroom accessories present on all major European markets. With the experience gathered over the years we came to the decision of launching this range of products, which through rigorous quality control and universal design perfectly fit into the nature of public space.

Spis treści / Table of contents

- 4** Podajniki na papier
Paper dispensers
- 6** Suszarki automatyczne
Automatic dryers
- 7** Dozowniki mydła
Soap dispensers
- 11** Kosze na śmieci
Waste baskets
- 12** Akcesoria uzupełniające
Supplementary accessories
- 14** Materiały eksploatacyjne
Exploataation materials
- 15** Akcesoria PRO dla niepełnosprawnych
PRO Handicap accessories
- 19** Wybór akcesoriów łazienkowych BISK
Selected BISK bathroom accessories





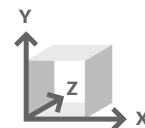

PODAJNIKI NA PAPIER

paper dispensers



07235

PL-P4
ABS
czarny / black
X 294 Y 263 Z 148
papier w listkach / paper towels
500 szt., 25x23 cm
500 pcs, 25x23 cm



07236

Jumbo-P4
ABS
czarny / black
X 258 Y 267 Z 117
rolki papieru max Ø 23 cm
for toilet rolls max Ø 23 cm



00398

PL-P2
ABS
srebrny mat / silver matt
X 294 Y 263 Z 148
papier w listkach / paper towels
500 szt., 25x23 cm
500 pcs, 25x23 cm



00505

Jumbo-P2
ABS
srebrny mat / silver matt
X 258 Y 267 Z 117
rolki papieru max Ø 23 cm
for toilet rolls max Ø 23 cm



00344

PL-P1
ABS
biały / white
X 294 Y 263 Z 148
papier w listkach / paper towels
500 szt., 25x23 cm
500 pcs, 25x23 cm



00399

Jumbo-P1
ABS
biały / white
X 258 Y 267 Z 117
rolki papieru max Ø 23 cm
for toilet rolls max Ø 23 cm



03863

PRP-1
PP
biały / white
X 270 Y 165 Z 150
rolki papieru Ø14 cm
paper rolls Ø14 cm
papier w listkach / paper towels
250 szt., 25x23 cm
250 pcs, 25x23 cm



04305

PU-P1
ABS
biały / white
X 150 Y 290 Z 140
rolki papieru 2x Ø12 cm
for toilet rolls 2x Ø12 cm
papier w listkach 11,5x12,5 cm
paper towels 11,5x12,5 cm

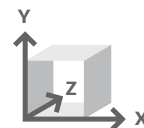

PODAJNIKI NA PAPIER

paper dispensers



00342

PL-S1
stal nierdzewna / stainless steel
szczotkowana / brushed
X 284 Y 266 Z 100
papier w listkach / paper towels
500 szt., 25x23 cm
500 pcs, 25x23 cm



00343

Jumbo-S1
stal nierdzewna / stainless steel
szczotkowana / brushed
X 254 Y 262 Z 115
rolki papieru max Ø 23 cm
for toilet rolls max Ø 23 cm



01571

PL-S2
stal nierdzewna / stainless steel
chrom / chrome
X 284 Y 266 Z 100
papier w listkach / paper towels
500 szt., 25x23 cm
500 pcs, 25x23 cm



01570

Jumbo-S2
stal nierdzewna / stainless steel
chrom / chrome
X 254 Y 262 Z 115
rolki papieru max Ø 23 cm
for toilet rolls max Ø 23 cm



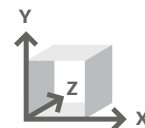

SUSZARKI AUTOMATYCZNE

automatic dryers



01801

SRM-S1
stal nierdzewna / stainless steel
szczotkowana / brushed
X 260 Y 235 Z 145
2300W, 78dB
CE



01574

SR-P2
ABS
srebrny mat / silver matt
X 240 Y 300 Z 145
1200W, 63dB
CE



01569

SR-S2
stal nierdzewna / stainless steel
chrom / chrome
X 220 Y 280 Z 160
1650W, 63dB
CE



00194

SR-P1
ABS
biała / white
X 240 Y 300 Z 145
1200W, 63dB
CE



00195

SR-S1
stal nierdzewna / stainless steel
szczotkowana / brushed
X 220 Y 280 Z 160
1650W, 63dB
CE



00241

SU-P1
ABS
biały / white
X 180 Y 280 Z 125
800W, 67dB
CE



01802

SH-P1
ABS
biały / white
X 90 Y 220 Z 145
1200W, 75dB
CE



także do: płyn dezynfekujący
also for disinfection liquid

MASTERLINE
by Bisk

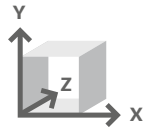

DOZOWNIKI MYDŁA

soap dispensers



02280

L1 / ABS
biały / white
X 110 Y 275 Z 100
1000 ml



02281

L2 / ABS
srebrny mat / silver matt
X 110 Y 275 Z 100
1000 ml



07238

L4/ABS
czarny / black
X 110 Y 275 Z 100
1000 ml



02275

K1/ABS
biały / white
X 90 Y 208 Z 100
500 ml



02276

K2/ABS
srebrny mat / silver matt
X 90 Y 208 Z 100
500 ml



07237

K4/ABS
czarny / black
X 90 Y 208 Z 100
500 ml



03558

ABS
biały / white
X 97 Y 210 Z 104
500 ml



02923

P1/ABS
biały / white
X 98 Y 210 Z 115
750 ml



03133

P2/ABS
srebrny mat / silver matt
X 98 Y 210 Z 115
750 ml



07239

L1 / ABS
czarny / black
X 98 Y 210 Z 115
750 ml





także do: płyn dezynfekujący
also for disinfection liquid



system bezdotykowy
no-touch

MASTERLINE
by Bisk

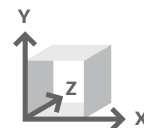

DOZOWNIKI MYDŁA

soap dispensers



04957

D1

stal nierdzewna / stainless steel
szcztokowana / brushed
X 97 Y 295 Z 105
1000 ml



05880

D2

stal nierdzewna / stainless steel
chrom / chrome
X 97 Y 295 Z 105
1000 ml



04959

DP1

stal nierdzewna / stainless steel
szcztokowana / brushed
X 97 Y 295 Z 105
1000 ml



automatic

07603

DA1

stal nierdzewna / stainless steel
szcztokowana / brushed
X 95 Y 255 Z 92
800 ml



06389

DM1

stal nierdzewna / stainless steel
szcztokowana / brushed
X 100 Y 230 Z 105
500 ml



06390

DM2

stal nierdzewna / stainless steel
chrom / chrome
X 100 Y 230 Z 105
500 ml



06391

DP-M1

stal nierdzewna / stainless steel
szcztokowana / brushed
X 100 Y 230 Z 105
500 ml



01416

stal nierdzewna / stainless steel
chrom / chrome
X 125 Y 202 Z 117
1000 ml



01417

stal nierdzewna / stainless steel
szcztokowana / brushed
X 125 Y 202 Z 117
1000 ml



01415

stal nierdzewna / stainless steel
chrom / chrome
X 98 Y 153 Z 105
500 ml



04084

stal nierdzewna / stainless steel
szcztokowana / brushed
X 103 Y 150 Z 105
500 ml



także do: płyn dezynfekujący
also for disinfection liquid



system bezdotykowy
no-touch

MASTERLINE
by Bisk

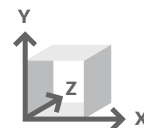

DOZOWNIKI MYDŁA

soap dispensers



▶ automatic

07757

AL1 / ABS
biały / white
X 145 Y 252 Z 100
1000 ml



▶ automatic

05903

AK1 / ABS
biały / white
X 95 Y 217 Z 92
500 ml



▶ automatic

05904

AK2 / ABS
srebrny mat / silver matt
X 95 Y 217 Z 92
500 ml



▶ automatic

05905

AK3 / ABS
chrom / chrome
X 95 Y 217 Z 92
500 ml



▶ automatic

06672

AS1 / stal nierdzewna / stainless steel / ABS
chrom / chrome
X 75 Y 185 Z 110
225 ml



▶ automatic

00588

ABS
biały / white
X 110 Y 220 Z 100
500 ml



▶ automatic

00589

ABS
srebrny mat / silver matt
X 110 Y 220 Z 100
500 ml



72027

ABS
biały / white
X 80 Y 195 Z 85
350 ml



72067

ABS
srebrny mat / silver matt
X 80 Y 195 Z 85
350 ml



72075

ABS
chrom / chrome
X 80 Y 195 Z 85
350 ml

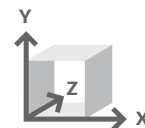

DOZOWNIKI MYDŁA

soap dispensers



00174

ABS
biały / white
X 138 Y 250 Z 80
2x400 ml



00175

ABS
chrom / chrome
X 138 Y 250 Z 80
2x400 ml



00173

ABS
chrom / chrome
X 84 Y 250 Z 80
400 ml



00172

ABS
biały / white
X 84 Y 250 Z 80
400 ml



07402

A1 / ABS
biały / white
X 98 Y 157 Z 85
500 ml



07517

A2 / ABS
srebrny mat / silver matt
X 98 Y 157 Z 85
500 ml



07600

A3 / ABS
chrom / chrome
X 98 Y 157 Z 85
500 ml



07802

C / ABS
biały / white
X 113 Y 190 Z 110
1000 ml



04760

BL1 / **mosiądz** / solid brass
nikiel szczotkowany / brushed nickel

04759

BL2 / **mosiądz** / solid brass
chrom / chrome
X 180 Y 448 Z 90
1000 ml



07702

B / ABS
biały / white
X 81 Y 280 Z 105
1000 ml

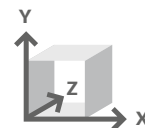

KOSZE NA ŚMIECI

waste baskets

STAL NIERDZEWNA / STAINLESS STEEL

CHROM / CHROME



02479 3L

X 165 Y 255 Z 225

00283 5L

X 205 Y 280 Z 260

00056 7L

X 205 Y 315 Z 260

00430 12 L

X 250 Y 375 Z 300

00060 20 L

X 295 Y 440 Z 335

SZCZOTKOWANA / BRUSHED



00125 3L

X 165 Y 255 Z 225

03275 5L

X 205 Y 280 Z 260

00431 12 L

X 250 Y 375 Z 300

01017 20 L

X 295 Y 440 Z 335



00122 6L

chrom / chrome
X 205 Y 295 Z 250

04045 >



04045

pokrywa kosza / lid
X 425 Y 25 Z 195

00390 >

00390 35 L

szcotkowana / brushed
X 420 Y 490 Z 195

▲ mocowany do ściany
wall mounted

POLIPROPYLEN / POLIPROPYLENE



91927 10 L

biały / white
X 240 Y 410 Z 240



93002 15 L

biały / white
X 275 Y 500 Z 275



93902 8 L

biały / white
X 250 Y 370 Z 230



90302 5 L

biały / white
X 200 Y 300 Z 200

PRZEWIJAK DLA DZIECKA / BABY CHANGING TABLE
Towar dostępny na zamówienie / Article available on request

06217

poziom / horizontal
X 872 Y 512 Z 513



06216

pion / vertical
X 560 Y 899 Z 903



Atest PZH

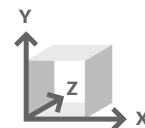

AKCESORIA UZUPEŁNIAJĄCE

supplementary accessories

NEW

▲ mocowany do ściany
wall mounted



07963

stal nierdzewna / stainless steel
szczotkowana / brushed
X 89 Y 410 Z 110

NEW

▲ mocowany do ściany
wall mounted



07964

stal nierdzewna / stainless steel
szczotkowana / brushed
X 89 Y 100 Z 110



00119

stal nierdzewna / stainless steel
chrom / chrome
X 110 Y 375 Z 110



00121

stal nierdzewna / stainless steel
szczotkowana / brushed
X 110 Y 375 Z 110



00176

stal nierdzewna / stainless steel
chrom / chrome
X 100 Y 370 Z 100



00234

stal nierdzewna / stainless steel
szczotkowana / brushed
X 100 Y 370 Z 100



01016

stal nierdzewna / stainless steel
szczotkowana / brushed
X 95 Y 380 Z 110



71429

stal nierdzewna / stainless steel
chrom / chrome
X 95 Y 380 Z 110



02722

PP
biały / white
X 120 Y 350 Z 120



93702

PP
biały / white
X 125 Y 355 Z 125



80502

PP
biały / white
X 160 Y 360 Z 160

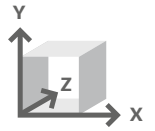

AKCESORIA UZUPEŁNIAJĄCE

supplementary accessories

STAL NIERDZEWNA / STAINLESS STEEL



00046

chrom / chrome
X 135 Y 30 Z 90



00047

chrom / chrome
X 205 Y 30 Z 95



00045

chrom / chrome
X 235 Y 30 Z 170



00044

chrom / chrome
X 195 Y 30 Z 120



00048

chrom / chrome
X 235 Y 335 Z 170



02542

szcztokowany nikiel / brushed nickel
X 550 Y 140 Z 232

02543

chrom / chrome
X 550 Y 140 Z 232



00042

chrom / chrome
X 625 Y 180 Z 275



aluminium

00081

chrom / chrome
90x90x90cm, Ø 20mm



aluminium

72502

biały / white
90x90x90cm, Ø 20mm



00080

stal nierdzwerna / stainless steel chrom
/ chrome
70x120cm, Ø 22mm

00037

stal nierdzwerna / stainless steel chrom
/ chrome
125x220cm, Ø 22mm



72202

aluminium
biały / white
70x120cm, Ø 22mm

72402

aluminium
biały / white
125x220cm, Ø 22mm

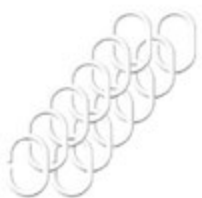

kpl. 12szt. / set of 12pcs

91202

plastik / plastic
biały / white

97200

plastik / plastic
przezroczysty / transparent



03502

PEVA
biały / white
180x200 cm



08702

TXT
biały / white
180x200 cm

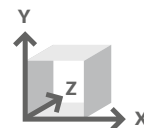

AKCESORIA UZUPEŁNIAJĄCE

supplementary accessories

STAL NIERDZEWNA / STAINLESS STEEL



71275

chrom / chrome

04790

biały / white

71276

szcztokowana / brushed
X 265 Y 55 Z 70
Ø 19 mm



71850

chrom / chrome

04811

biały / white

71851

szcztokowana / brushed
X 335 Y 55 Z 80
Ø 22 mm



04791

biały / white

71875

chrom / chrome

71876

szcztokowana / brushed
X 380 Y 240 Z 80
Ø 25 mm



71925

chrom / chrome

71926

szcztokowana / brushed
X 115 Y 200 Z 440
Ø 25 mm



01419

szcztokowana / brushed
X 140 Y 90 Z 105



01418

chrom / chrome
X 140 Y 90 Z 105



00102

chrom / chrome
X 640 Y 55 Z 80
Ø 25 mm

04812

biały / white
X 640 Y 55 Z 80
Ø 25 mm

MATERIAŁY EKSPLOATACYJNE

exploitation materials



03353

MINI – Ø 14 cm
długość / length: 60 m



03354

MINI – Ø 14 cm
długość / length: 65 m



03355

JUMBO – Ø 18,5 cm
długość / length: 120 m



05890

ZZ
rozmiar / size: 25x23 cm



03158 5L

mydło w pianie
soft foam soap



02795 5L

mydło w płynie
liquid soap



02796 1L

mydło w płynie
liquid soap

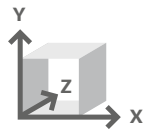

AKCESORIA DLA NIEPEŁNOSPRAWNYCH

disabled accessories



LAT 5 YEARS Gwarancja

Atest PZH



stal nierdzewna / stainless steel / Ø 25 mm

max 150 kg / test 225 kg

max 120 kg / test 180 kg

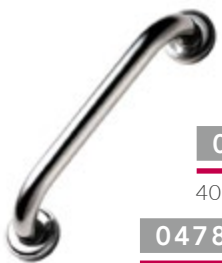

04779

chrom / chrome
250 mm



04778

biały / white
250 mm



05499

chrom / chrome
600 mm

04781

400 mm

04780

400 mm

04783

600 mm

04782

600 mm



05498

biały / white
600 mm



04785

chrom / chrome
550x550 mm



04784

biały / white
550x550 mm

stal nierdzewna / stainless steel
Ø 25 mm

max 120 kg / test 180 kg



04787

chrom / chrome
700 mm



04777

chrom / chrome
220x220 mm



04776

biały / white
220x220 mm



04786

biały / white
700 mm

rysunki techniczne - str. 25 / technical drawings - p. 25



Wyroby zgłoszone w Urzędzie Rejestracji Produktów Leczniczych, Wyrobów Medycznych i Produktów Biobójczych jako Wyrób Medyczny Klasy I. Carry the CE mark, have hygienic approval from the National Institute of Hygiene of the Polish Institute of Public Health, are registered with The Office for Registration of Medicinal Products, Medical Devices and Biocidal Products as Class I medical devices.

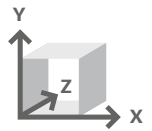

AKCESORIA DLA NIEPEŁNOSPRAWNYCH

disabled accessories



LAT 5 YEARS Gwarancji Atest PZH

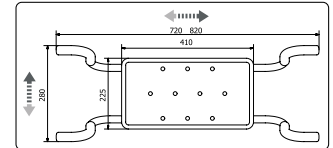

max 120 kg / test 180 kg



07623

AI/ABS
X 340 Y 110 Z 333

max 120 kg / test 180 kg



06218

AI/PE
X 720-820 Y 180 Z 280



max 120 kg / test 180 kg

NEW



07604

PP
X 480 Y 205 Z 335



CE Wyroby zgłoszone w Urzędzie Rejestracji Produktów Leczniczych, Wyrobów Medycznych i Produktów Biobójczych jako Wyrób Medyczny Klasy I.

Carry the CE mark, have hygienic approval from the National Institute of Hygiene of the Polish Institute of Public Health, are registered with The Office for Registration of Medicinal Products, Medical Devices and Biocidal Products as Class I medical devices.



Atest PZH



04956

stal nierdzewna / stainless steel
chrom / chrome
X 103 Y 680 Z 103



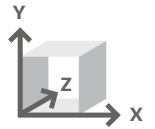

AKCESORIA DLA NIEPEŁNOSPRAWNYCH

disabled accessories

max 150 kg / test 225 kg



gwarancja
5
LAT
YEARS
guarantee

Atest
PZH



07639

AI/PE

X 495 Y 385-560 Z 295



07640

AI/PE

X 485 Y 360-530 Z 330



07705

AI/PE

X 440 Y 348-526 Z 440



07657

AI/PE

X 495 Y 680-855 Z 295



07658

AI/PE

X 485 Y 675-845 Z 330



Wyroby zgłoszone w Urzędzie Rejestracji Produktów Leczniczych, Wyrobów Medycznych i Produktów Biobójczych jako Wyrób Medyczny Klasy I. Carry the CE mark, have hygienic approval from the National Institute of Hygiene of the Polish Institute of Public Health, are registered with The Office for Registration of Medicinal Products, Medical Devices and Biocidal Products as Class I medical devices.

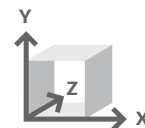

AKCESORIA DLA NIEPEŁNOSPRAWNYCH

disabled accessories

Towar dostępny na zamówienie / Article available on request

stal nierdzewna / stainless steel



00163

chrom / chrome
60 cm, Ø30 mm

stal malowana / painted steel



01398

biały / white
60 cm, Ø25 mm

stal nierdzewna / stainless steel



00167

chrom / chrome, Ø30 mm
75 x 80 cm, **prawy** / right

stal malowana / painted steel



01400

biały / white, Ø25 mm
75 x 60 cm, **prawy** / right

01384

chrom / chrome, Ø30 mm
75 x 80 cm, **lewy** / left

01524

biały / white, Ø25 mm
75 x 60 cm, **lewy** / left



stal nierdzewna / stainless steel

01385

chrom / chrome
60 x 60 cm



stal nierdzewna / stainless steel

00165

chrom / chrome, Ø30 mm
55 cm, **prawy** / right

00166

chrom / chrome, Ø30 mm
55 cm, **lewy** / left



stal nierdzewna / stainless steel

01386

45 x 40 cm
chrom / chrome, Ø25 mm

stal malowana / painted steel

01527

45 x 40 cm
biały / white, Ø25 mm



stal malowana / painted steel

01390

biały / white, Ø25 mm
50 cm, **prawy** / right

01391

biały / white, Ø25 mm
50 cm, **lewy** / left

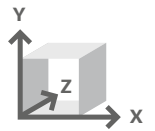

WYBRANE KOLEKCJE

supplementary accessories

NATURE GOLD

PVD / PVD



07949

X 20 Y 45 Z 23



07950

X 55 Y 48 Z 22



07951

X 225 Y 147 Z 20



05912

X 130 Y 45 Z 75



05851

X 223 Y 50 Z 223



05911

X 100 Y 375 Z 127



05850

X 70 Y 150 Z 100

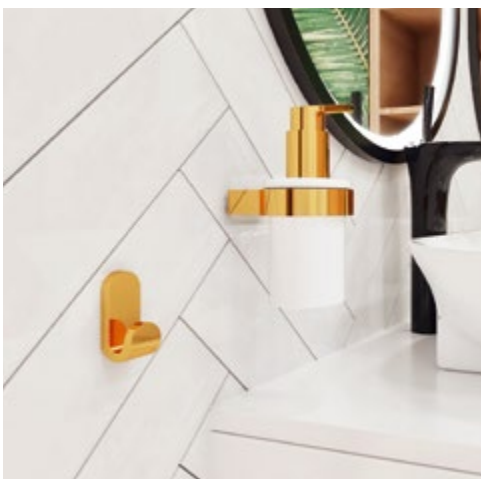

MOCOWANIA
FIXINGS
montaż przy pomocy śrub
installation with screws



OPAKOWANIE
PACKAGING
colour box

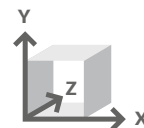

WYBRANE KOLEKCJE

supplementary accessories

BERGEN

CHROM & HPL / CHROME & HPL



07104

X 230 Y 120 Z 115



07065

X 180 Y 120 Z 115



07101

X 100 Y 154 Z 130



07056 (450)

X 450 Y 40 Z 125



07053

X 150 Y 40 Z 115



07063

X 25 Y 50 Z 90



07103

X 190 Y 190 Z 60



07069 (310)

X 310 Y 40 Z 115



07061

X 180 Y 40 Z 115



07059

X 130 Y 360 Z 145

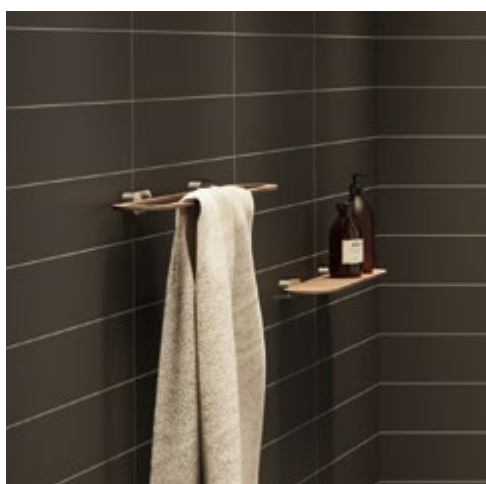

**MOCOWANIA
FIXINGS**
montaż przy pomocy śrub
installation with screws



**MOCOWANIA
FIXINGS**
montaż na klej B-FIX
installation with B-FIX glue



**MOCOWANIA
FIXINGS**
montaż na klej BISK FEST
installation with BISK FEST glue



**OPAKOWANIE
PACKAGING**
colour box

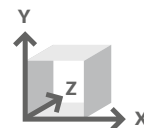

WYBRANE KOLEKCJE

supplementary accessories

FUTURA

CZARNA SATYNA / BLACK SATIN



02953

X 70 Y 140 Z 100



02965

X 25 Y 57 Z 40



02959

X 65 Y 93 Z 90



02963

X 132 Y 95 Z 30



02969

X 200 Y 175 Z 30



02961

X 135 Y 120 Z 30



02954

X 130 Y 40 Z 100



02952

X 175 Y 40 Z 60



02968

X 30 Y 75 Z 435



02962

X 30 Y 160 Z 70



02967 (610)

X 642 Y 30 Z 125



02956

X 246 Y 30 Z 246



02958

X 90 Y 395 Z 115



MOCOWANIA
FIXINGS
montaż przy pomocy śrub
installation with screws



OPAKOWANIE
PACKAGING
colour box

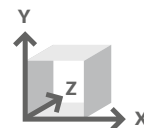

WYBRANE KOLEKCJE

supplementary accessories

FOR YOU

CHROM / CHROME



01177

X 125 Y 175 Z 90



02943

X 100 Y 60 Z 65



01176

X 155 Y 45 Z 90



01173

X 70 Y 45 Z 50



02924

X 110 Y 70 Z 130



03038

X 155 Y 100 Z 65



01174

X 125 Y 95 Z 85



01175

X 190 Y 95 Z 85



01180

X 640 Y 45 Z 65



01178

X 160 Y 165 Z 65



01181

X 640 Y 45 Z 115



01183

X 525 Y 45 Z 155



01179

X 160 Y 125 Z 65



01182

X 165 Y 375 Z 125



MOCOWANIA
FIXINGS
montaż przy pomocy śrub
installation with screws



MOCOWANIA
FIXINGS
montaż na klej BISK FEST
installation with BISK FEST glue



OPAKOWANIE
PACKAGING
blister

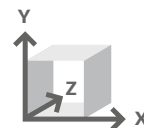

WYBRANE KOLEKCJE

supplementary accessories

VIRGINIA

DEDYKOWANA KOLEKCJA ARMATURY / DEDICATED FAUCET COLLECTION
SZCZOTKOWANY NIKIEL / BRUSHED NICKEL



72089

X 65 Y 155 Z 115



72080

X 66 Y 90 Z 110



72079

X 140 Y 130 Z 60

5 LAT GWARANCJI
YEARS GUARANTEE



00300

mosiądz / solid brass
single lever bath mixer
bateria wannowa
X 255 Y 60 Z 205



72092

X 60 Y 165 Z 70



72077

X 70 Y 60 Z 50



72142*

X 210 Y 50 Z 30



72082

X 135 Y 60 Z 125

5 LAT GWARANCJI
YEARS GUARANTEE



00285

mosiądz / solid brass
single lever, high neck, basin mixer
bateria umywalkowa wysoka
X 57 Y 305 Z 165



72076

X 605 Y 60 Z 155

5 LAT GWARANCJI
YEARS GUARANTEE



00181

zestaw natryskowy / shower set
klej BISK FEST / BISK FEST glue
łatwy montaż / easy to fix
X 140 Y 600 Z 120



72087

X 620 Y 60 Z 160



72088

X 115 Y 375 Z 155



00305

mosiądz / solid brass
bateria prysznicowa
single lever shower mixer
X 255 Y 60 Z 145



MOCOWANIA
FIXINGS
montaż przy pomocy śrub
installation with screws



MOCOWANIA
FIXINGS
montaż na klej BISK FEST
installation with BISK FEST glue



OPAKOWANIE
PACKAGING
blister

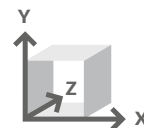

WYBRANE KOLEKCJE

supplementary accessories

OCEANIC

POLISTYREN / POLYSTERENE



47242

X 185 Y 95 Z 105



40742

X 120 Y 95 Z 120



40442

X 160 Y 130 Z 70



46842

X 40 Y 60 Z 45



41142

X 325 Y 70 Z 70



40842

X 120 Y 35 Z 35



41042

X 580 Y 50 Z 140



47142

X 235 Y 90 Z 75



40542

X 160 Y 40 Z 110



40242

X 585 Y 60 Z 140



47042

X 585 Y 85 Z 90



51302

X 440 Y 440 Z 40



OPAKOWANIE
PACKAGING
blister

RYSUNKI TECHNICZNE

technical drawings

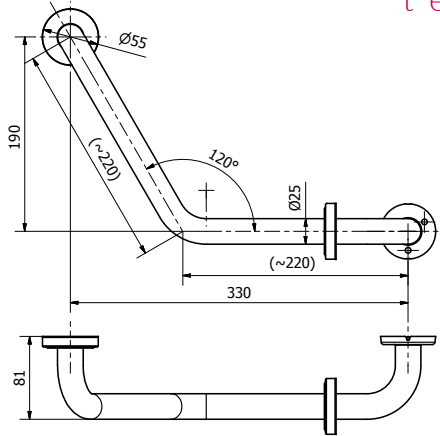

04777

04776

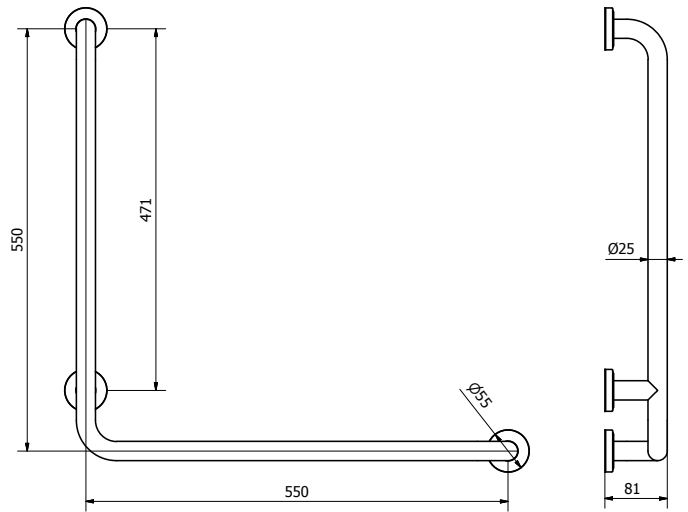

04785

04784

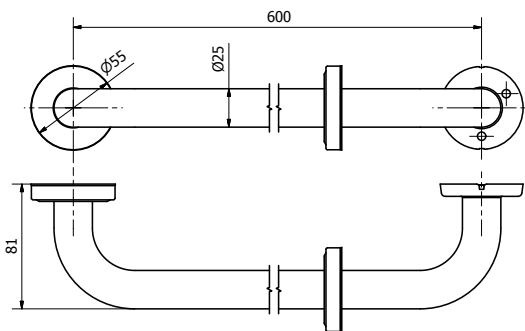

04783

04782

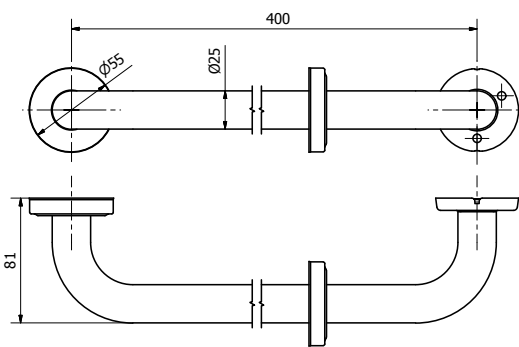

04781

04780

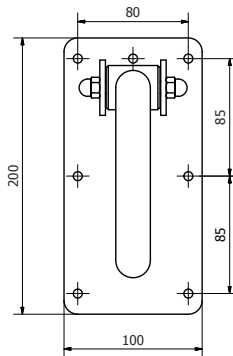

04787

04786

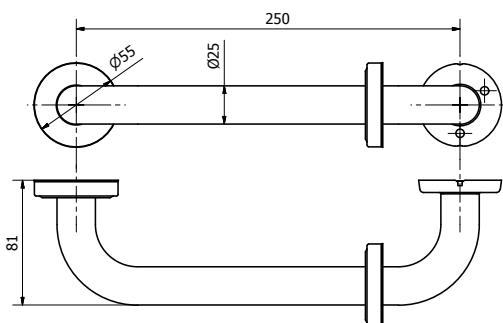
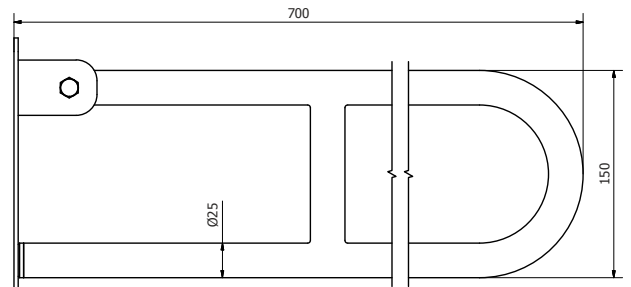

04779

04778

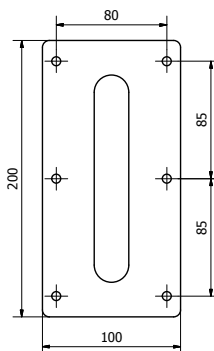

05498

05499

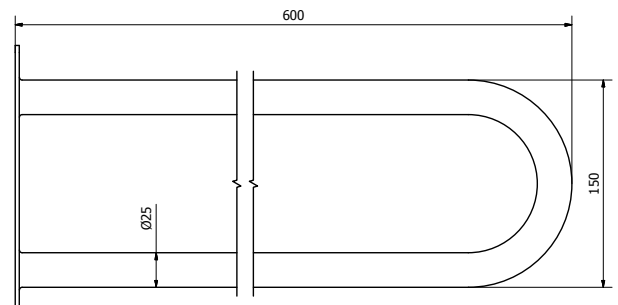



Safe home



Bezpieczny dom



